

Last information update: March 2025

Product configuration: 101C.01

101C.01: LV Ø80 pendant projector for Filorail - Optibeam Lens - DALI Powerline - 13.7W 1043.4lm - 4000K - CRI 90 - White

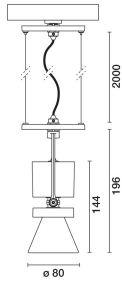

Product code

101C.01: LV Ø80 pendant projector for Filorail - Optibeam Lens - DALI Powerline - 13.7W 1043.4lm - 4000K - CRI 90 - White

Technical description

Miniaturised adjustable pendant luminaire with adapter for installation on a 48V Filorail low voltage track. High yield LED lamp with high color rendering index. Adjustable pendant spotlight made of die-cast aluminium and thermoplastic material. Balanced pendant system with double steel cable - L max 2000 mm - and adjustment system. DC/DC driver circuit with dimmable DALI function integrated in the body. The Dali «power line» technology allows each spotlight on the track to be adjusted separately. Luminaire body made of die-cast aluminium and thermoplastic material. Swivel joints allow the spotlight to be rotated by 360° about the vertical axis and tilted by 90° tilting relative to the horizontal plane. The set back position of the optic unit guarantees a high level of visual comfort. High definition lens in thermoplastic material. Mechanical aiming locks fitted on both the spotlight and adapter allow rotation and tilting movements to be locked in position to ensure efficient light aiming even after the original installation or during maintenance. The optical assembly is equipped with an accessory holding ring designed to contain a flat accessory. Another external component that rotates freely around the spotlight's longitudinal axis can also be applied.

Installation

Installation on a Filorail track.

Colour

White (01)

Mounting

Low voltage track

Wiring

LED driver integrated in product body - direct connection on 48V track. Track power supply unit to be ordered separately.

Complies with EN60598-1 and pertinent regulations



Technical data

lm system:	1043	Colour temperature [K]:	4000
W system:	13.7	MacAdam Step:	2
lm source:	1410	Life Time LED 1:	> 50,000h - L90 - B10 (Ta 25°C)
W source:	13	Voltage [Vin]:	48
Luminous efficiency (lm/W, real value):	76.2	Lamp code:	LED
lm in emergency mode:	-	Number of lamps for optical assembly:	1
Total light flux at or above an angle of 90° [Lm]:	0	ZVEI Code:	LED
Light Output Ratio (L.O.R.) [%]:	74	Number of optical assemblies:	1
Beam angle [°]:	28°	Control:	DALI
CRI (minimum):	90		

Polar

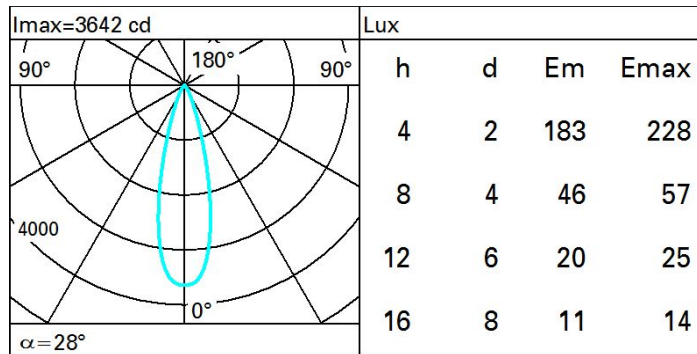

Isolux

