

# LASER BLADE ADJUSTABLE

SINGLE / DOUBLE

Type:

SPECIFICATION SHEET

Project :

Page: 1 of 5

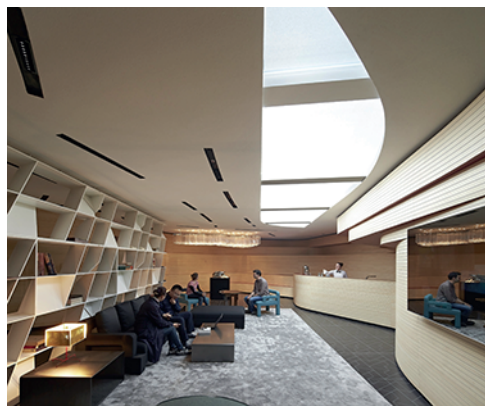
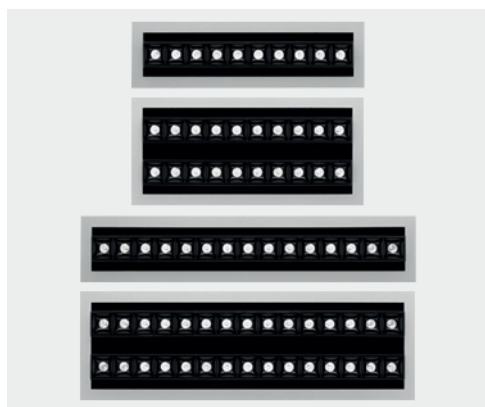

Laser Blade Adjustable adapts to the evolution of space: concentrating or widening the diameter of the lit area and highlighting objects. The luminaire's internal rotation of  $\pm 30^\circ$  around the horizontal axis with continuous friction, optimizes precision aiming. In its single and double version, the product, which can also be positioned vertically, pushes back the frontiers of adjustability.

## Luminaire characteristic:

### Power input:

Single: 24.7W or 36.6W (system wattage)  
Double: 2 x 24.7W or 2 x 36.6W (system wattage)  
**Lumens:** 1661lm to 5166lm (for 3000K, 92CRI)  
**Luminaire efficacy:** up to 70lm/W

### Source:

White LED module (LM-80)  
3000K: 92CRI (90CRI min),  
3500K: 92CRI (90CRI min),  
4000K: 92CRI (90CRI min).

### Lumen maintenance:

90% of initial lumens at 50 000 hours (L90) (LM-79).

### Optics:

Low luminance: Spot, flood and wide flood optics with Opti Beam technology. Head adjustable lengthwise up to 30 degrees.

### Material:

Body and heat sink: Die-cast aluminum  
Reflector and baffle: Thermoplastic  
Housing: Galvanized steel

### Mounting:

New construction plaster frame suitable for non-insulated ceiling.

### Electrical:

Integral high efficiency LED driver, rated at 50 000 hours

### Dimming:

0-10V dimming (120-277V) or leading (TRIAC) and trailing edge (ELV) dimming (120V only). Both options down to  $\pm 15\%$  dimming range.

### Finish:

Black, white (RAL9010) and grey (RAL9006) painted finish.

### Weight:

ILB10 single: 3.35lbs (1.52kg)  
ILB10 double: 6.17lbs (2.80kg)  
ILB15 single: 4.54lbs (2.06kg)  
ILB15 double: 7.41lbs (3.36kg)

### Warranty:

5 year limited warranty.

### Ratings:

IP20

### Certification:



cULus listed for damp location. Interior use only.

Energy star certified product. To confirm which versions are certified, please consult the product list: [www.energystar.gov/productfinder](http://www.energystar.gov/productfinder)

## ORDERING INFO



PRODUCT CODE			INSTALLATION CODE					
MODEL	MOUNTING	CONFIGURATION	INSTALLATION	LED	OPTIC	VOLTAGE	FINISH (trim / baffle finish)	DIMMING
<b>ILB10</b> 10 cells	<b>TR</b> Trim	<b>SG</b> Single	<b>NC</b> New construction plaster frame	<b>030</b> <sup>1</sup> 3000K, 92CRI	<b>ASP</b> <sup>2</sup> Adjustable spot 13°	<b>120</b> 120V	<b>01</b> White / black	<b>120V</b>
<b>ILB15</b> 15 cells		<b>DB</b> Double		<b>035</b> <sup>1</sup> 3500K, 92CRI	<b>AFL</b> <sup>2</sup> Adjustable flood 32°	<b>UNV</b> 120-277V	<b>02</b> Black / black	<b>LTE</b> Leading edge and trailing edge (down to 15%)
				<b>040</b> <sup>1</sup> 4000K, 92CRI	<b>AWF</b> Adjustable wide flood 47°		<b>10</b> Gray / black	<b>120-277V (UNV)</b>
								<b>D10</b> 0-10V (down to 15%)



<sup>1</sup> 92CRI typical - 90CRI minimum.  
<sup>2</sup> Available with **030** or **035** LED.

## INSTALLATION

### New construction with plaster frame (NC)

Plaster frame with hanger bars system to be installed during rough-in phase. Suitable for non-insulated ceiling assemblies, like sheetrock, or paneling. Plaster frame can be shipped separately.

**Ceiling thickness:** 1/8" to 1 1/8" (3mm to 29mm)

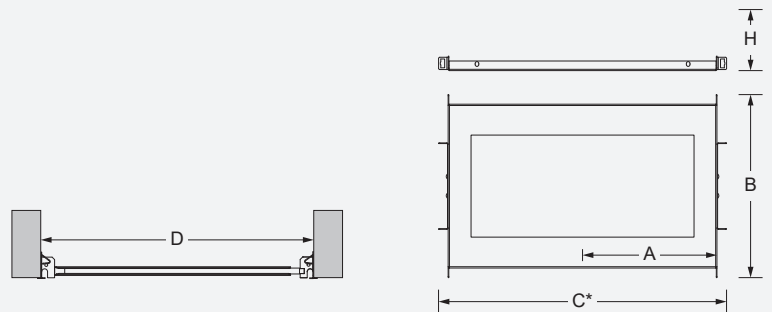

\*Provide a minimum of 1 1/8" (46mm) on each side for the hanger bar fixations

Model	Plaster frame	Cut-out dimensions	Cut-out positions (A)	Overall dimensions (BxC)	Hanger bars range (D)	Clearance (H)
<b>ILB10</b>	BN-LB10ADJ-SG-TR-NC	3 1/8" x 11 1/8" (80 x 295mm)	7" (178mm)	9 1/2" x 15" (242 x 381mm)	14 1/4" to 26" (362 to 660mm)	5 1/4" (144mm)
	BN-LB10ADJ-DB-TR-NC	5 7/8" x 11 1/8" (135 x 295mm)				
<b>ILB15</b>	BN-LB15ADJ-SG-TR-NC	3 1/8" x 16 7/8" (80 x 428mm)	9 1/2" (241mm)	9 1/2" x 20" (242 x 508mm)		
	BN-LB15ADJ-DB-TR-NC	5 7/8" x 16 7/8" (135 x 428mm)				

**DIMENSIONS**

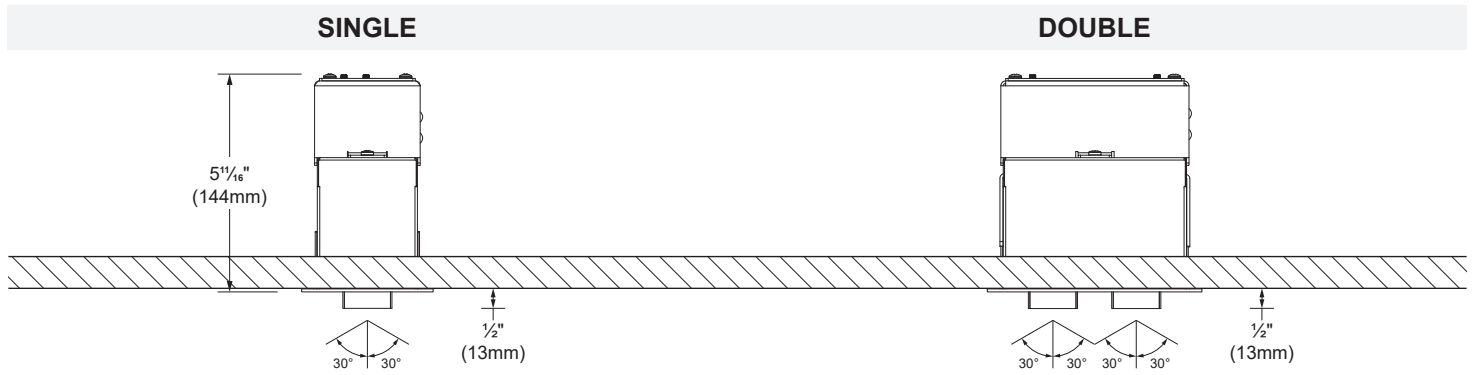

**SIDE VIEW**

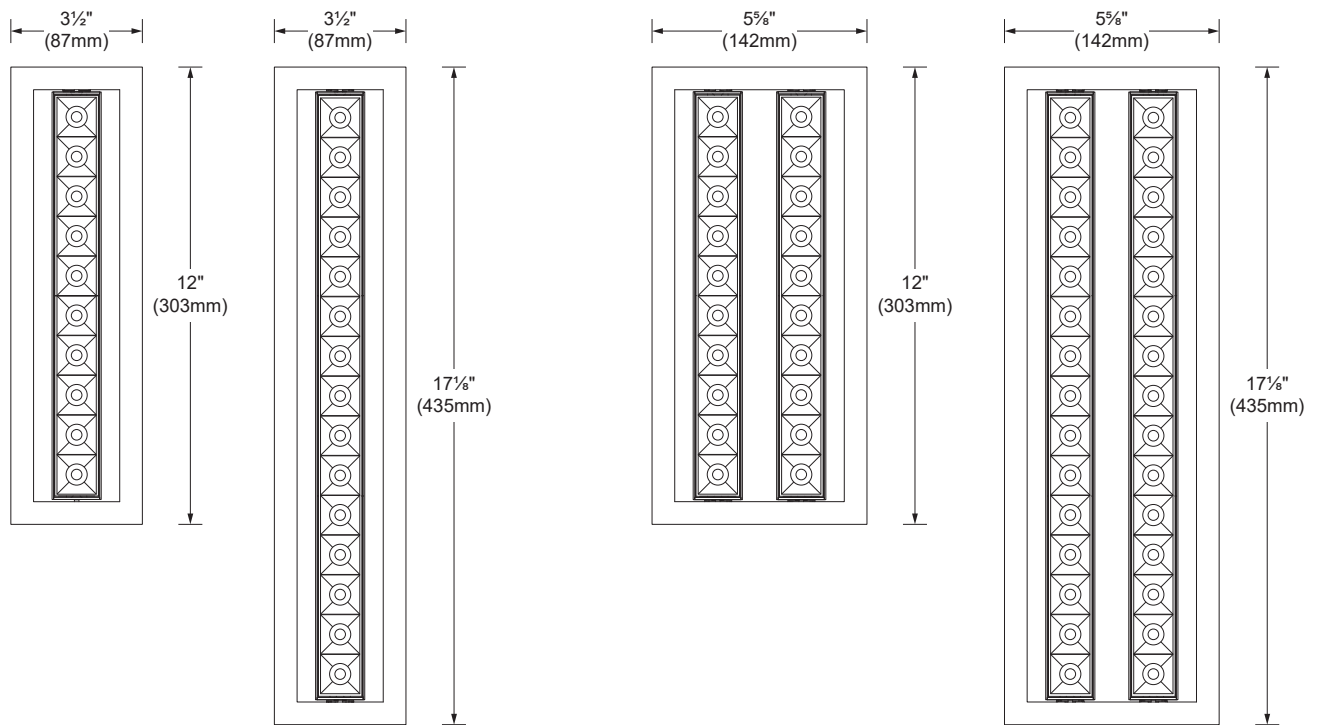

**BOTTOM VIEW**

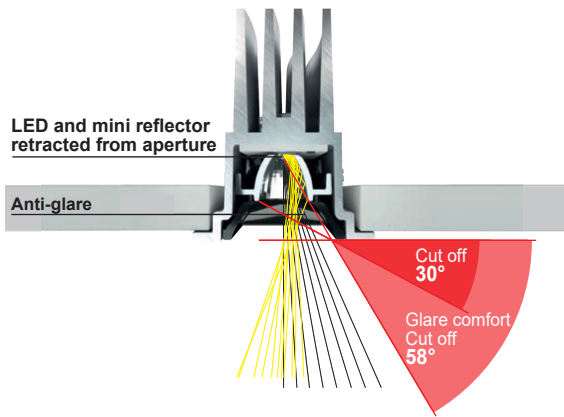

Visual comfort UGR < 10.

## LED COLOR FIDELITY DATA

CRI	CCT	R1	R2	R3	R4	R5	R6	R7	R8	R9	R10	R11	R12	R13	R14	R15	Rf	Rg	Melanopic ratio
92	3000K	93	97	98	92	93	95	92	82	60	91	92	82	94	99	90	92	99	0.571
	4000K	93	94	94	93	92	91	94	86	64	85	93	78	93	96	90	91	100	0.715

## PHOTOMETRIC DATA

\*Photometric data for each light module.

CCT (K)	CRI	LOAD (W)	OPTIC	LUMENS (lm)	EFFICACY (lm / W)	MAX CANDELA (cd)	MODELS
3000K	92	24.7W	Spot 13°	1 681	68	16 108	ILB10-030-ASP
			Flood 32°	1 661	67	5 578	ILB10-030-AFL
			Wide flood 47°	1 661	67	3 179	ILB10-030-AWF

Use multiplier table for other CCT and CRI output data. Efficacy based on IESNA LM-79 test reports. Visit [iguzzini.com/us](http://iguzzini.com/us) for complete photometric data.

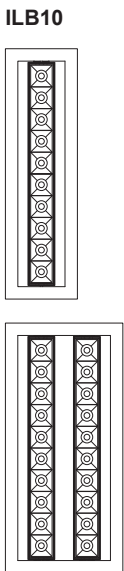

Spot 13° (3000K, 92CRI)

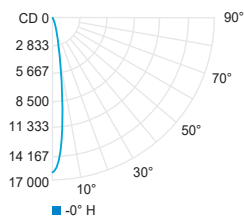

Center beam fc	Beam width ft
2ft 4 027	0.5
4ft 1 007	0.9
6ft 447	1.4
8ft 252	1.9
10ft 161	2.3
12ft 112	2.8

Flood 32° (3000K, 92CRI)

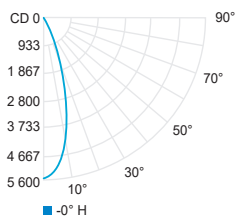

Center beam fc	Beam width ft
2ft 1 395	1.1
4ft 349	2.3
6ft 155	3.4
8ft 87.2	4.5
10ft 55.8	5.6
12ft 38.7	6.8

Wide flood 47° (3000K, 92CRI)

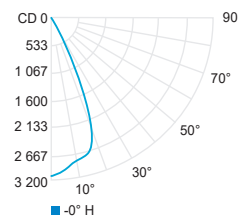

Center beam fc	Beam width ft
2ft 714	1.8
4ft 179	3.5
6ft 73.9	5.3
8ft 44.6	7.0
10ft 28.6	8.8
12ft 19.8	10.6

CCT options	3000K	3500K	4000K*
CRI options	92CRI	92CRI	92CRI*
<b>Multiplier</b>	<b>1</b>	<b>1.05</b>	<b>1.10*</b>

\*Available for wide flood (AWF) optic.

**PHOTOMETRIC DATA**

\*Photometric data for each light module.

**ILB15**

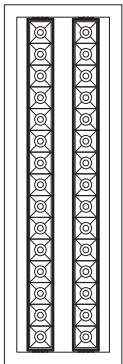
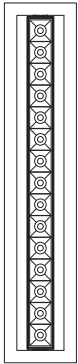

CCT (K)	CRI	LOAD (W)	OPTIC	LUMENS (lm)	EFFICACY (lm / W)	MAX CANDELA (cd)	MODELS
3000K	92	36.6W	Spot 13°	2 583	70	24 751	ILB15-030-ASP
			Flood 32°	2 552	69	8 571	ILB15-030-AFL
			Wide flood 47°	2 552	69	4 885	ILB15-030-AWF

Use multiplier table for other CCT and CRI output data. Efficacy based on IESNA LM-79 test reports. Visit [iguzzini.com/us](http://iguzzini.com/us) for complete photometric data.

Spot 13° (3000K, 92CRI)

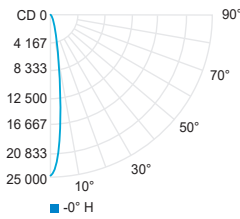

Center beam fc	Beam width ft
2ft	6 188 0.5
4ft	1 547 0.9
6ft	688 1.4
8ft	387 1.9
10ft	248 2.3
12ft	172 2.8

Flood 32° (3000K, 92CRI)

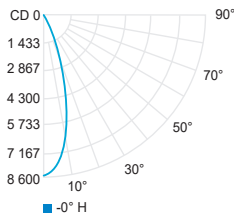

Center beam fc	Beam width ft
2ft	2 143 1.1
4ft	536 2.3
6ft	238 3.4
8ft	134 4.5
10ft	85.7 5.6
12ft	59.5 6.8

Wide flood 47° (3000K, 92CRI)

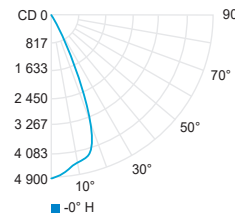

Center beam fc	Beam width ft
2ft	1 221 1.7
4ft	305 3.5
6ft	136 5.2
8ft	76.3 7.0
10ft	48.9 8.7
12ft	33.9 10.4

CCT options	3000K	3500K	4000K*
CRI options	92CRI	92CRI	92CRI*
<b>Multiplier</b>	<b>1</b>	<b>1.05</b>	<b>1.10*</b>

\*Available for wide flood (AWF) optic.