

Project name: _____

Type: _____



General information

Luminaire characteristics:

Input load: 14.4W/ft.

Lumens: 1 940 to 2 030/ft. (delivered)

Luminaire efficacy: 134 to 140 lm/W

Source: LED module 3000K: 80CRI, 4000K: 80CRI.

Optics: General lighting

Mounting: Adhesive backing, fixing clips or aluminum rigid channel.

Body: White flexible circuit coated with a layer of silicone.

Electrical: 24V per unit 3.94" (100mm). See remote power supply page 2.

Weight: 0.5lb (0.2kg) for 16ft (5m)

Warranty: 5 year limited warranty.

Certification: cULus listed.

Ratings: Dry location, IP20.

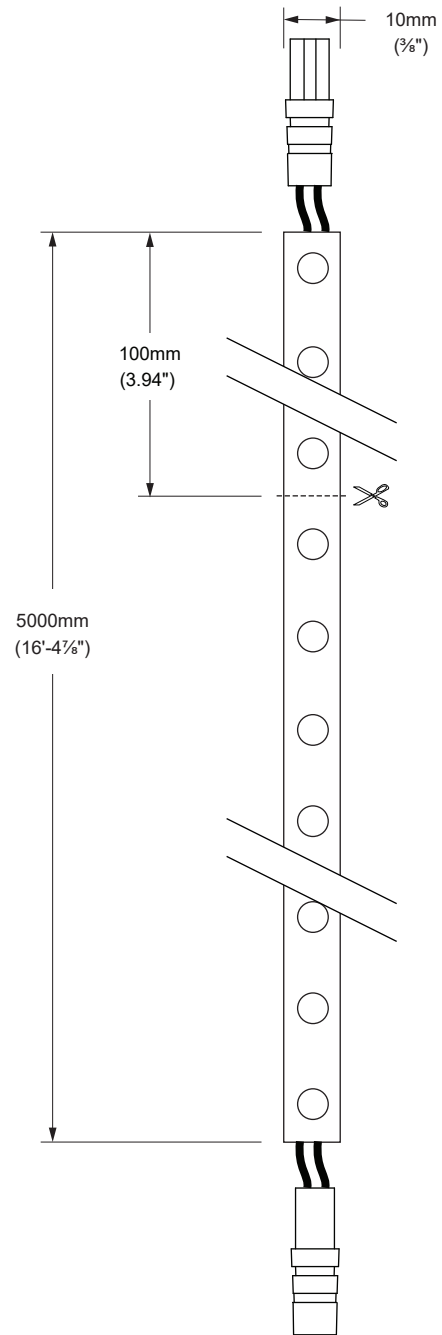

BOTTOM VIEW

Project name: _____

Type: _____

TECHNICAL DATA

Model:	IMI59-01
Color temp.:	3000K, 80CRI
Optic:	General lighting
Power input:	14.4W/ft
Lumens:	1 940 lm (delivered)
Luminaire efficacy:	134lm/W

Model:	IMI60-01
Color temp.:	4000K, 80CRI
Optic:	General lighting
Power input:	14.4W/ft
Lumens:	2 030 lm (delivered)
Luminaire efficacy:	140lm/W

Illuminance at Distance

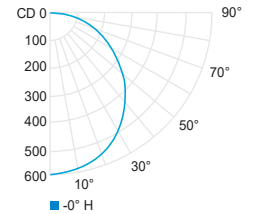
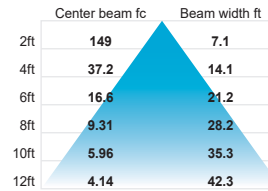

Illuminance at Distance

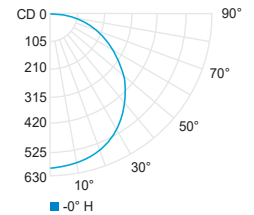
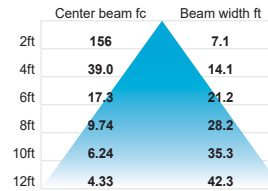

ACCESSORIES (TO BE ORDERED SEPARATELY)

IMWG1 - Five aluminum rigid channel
length: 39³/₈" (1000mm) 

IMWG2 - Fixing clips kit (include 10 clips) 

ORDERING INFO

<p>MODEL FINISH</p> <p>MODEL</p> <p><input type="radio"/> IMI59 - 3000K</p> <p><input type="radio"/> IMI60 - 4000K</p> <p>FINISH</p> <p><input type="radio"/> 01 - White</p> <p>LENGTH: _____ mm</p> <p>Order length in mm, by multiple of 100 (mm) Reference: 1" = 25.4mm / 1' = 304.8mm</p>	<p>REMOTE POWER SUPPLY OPTION</p> <p>REMOTE POWER SUPPLY OPTION* (TO BE ORDERED SEPARATELY)</p> <p>Requirement: 4.4W/ft, 24VDC *For other remote power supply options, please contact factory</p> <p><input type="radio"/> 4444-0024-025-120-ND: Dry location, non dimmable Quantity: Up to 5 linear feet Input: 120V AC DIM: 6" x 4" x 3" (152mm x 102mm x 76mm) Max distance 18AWG: 20ft (6m), for longer remote mounting distance, contact factory.</p> <p><input type="radio"/> 4448-0024-060-UNV-ND: Dry location, non dimmable Quantity: Up to 13 linear feet Input: 120-277V AC DIM: 10" x 8" x 4" (254mm x 203mm x 102mm) Max distance 18AWG: 20ft (6m), for longer remote mounting distance, contact factory.</p> <p><input type="radio"/> 4448-0024-100-UNV-ND: Dry location, non dimmable Quantity: Up to 22 linear feet Input: 120-277V AC DIM: 10" x 8" x 4" (254mm x 203mm x 102mm) Max distance 18AWG: 20ft (6m), for longer remote mounting distance, contact factory.</p>
--	--